

Puritan™ Model
Double Bowl
PBLD3321D65SN

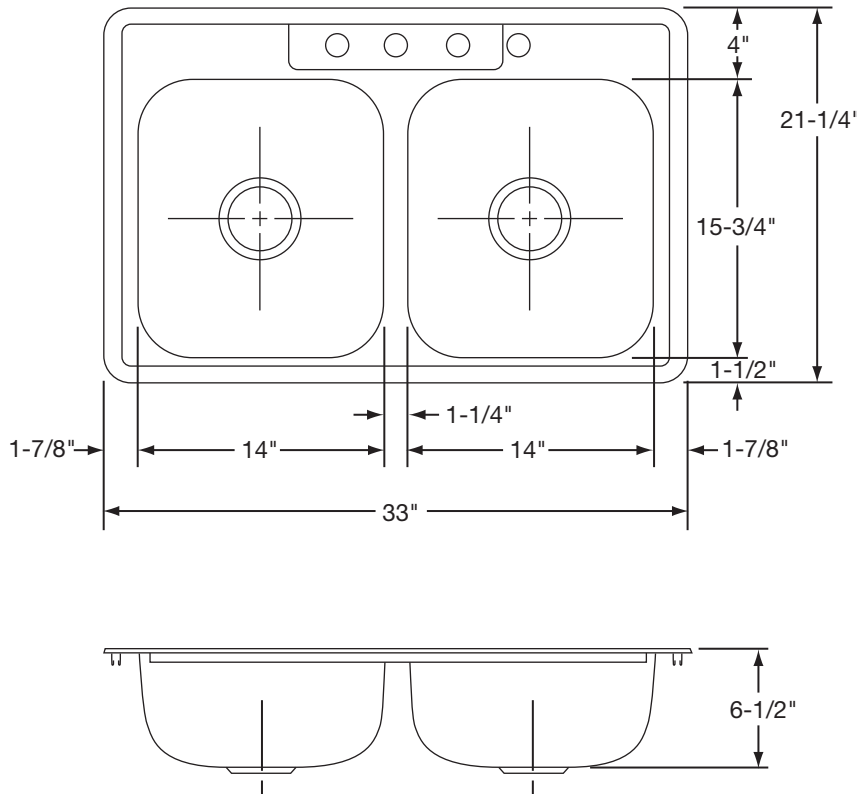

FEATURES:

- 300 Series Stainless Steel
- Self-Rimming / Drop-In
- Soft Satin-Buffered and Machine Ground
- 3-1/2" Center Drain Opening
- Full Undercoat Sound Deadening
- Includes Mounting Hardware/ Clips and Screws
- Hole Drillings: 3 or 4
- Suggested Cabinet Size: 36"
- Shipping Weight: 10-3/4 lbs.

ALL DIMENSIONS IN INCHES, TO CONVERT TO MILLIMETERS MULTIPLY BY 25.4.

In keeping with our policy of continuing product improvement, Revere Sink reserves the right to change product specifications without notice.

This specification describes a Revere Sink product with design, quality and functional benefits to the user. When making a comparison of other producers' offerings, be certain these features are not overlooked.