

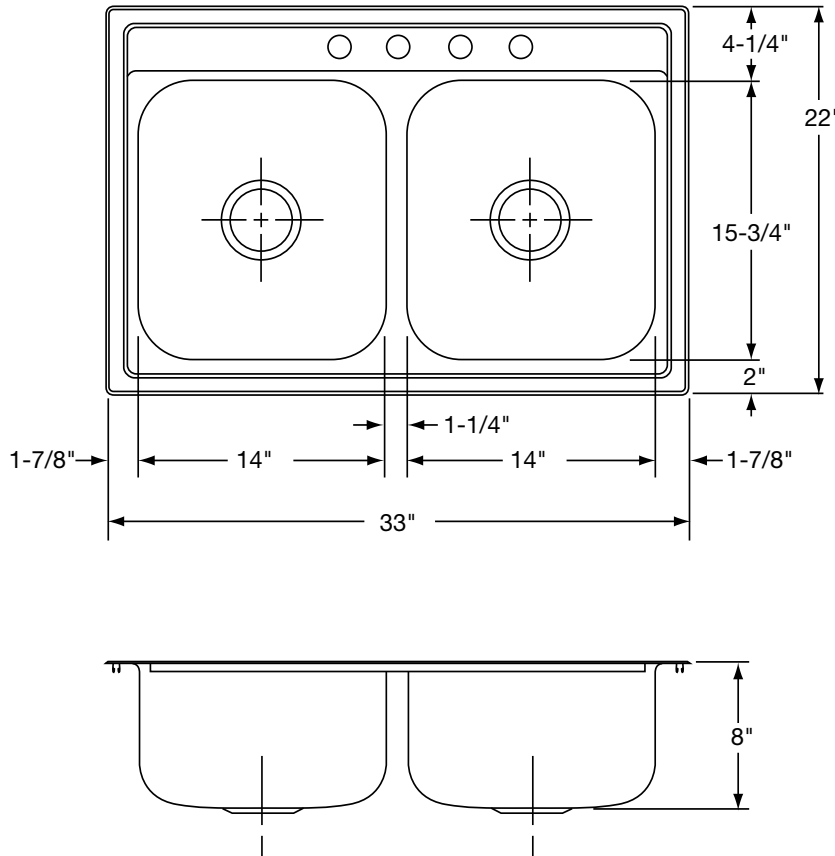

Specification Sheet

Carrington™ Model Double Bowl CLD3322D8DG



FEATURES:

- 20 Gauge 301 Nickel-Bearing Stainless Steel
- Self-Rimming / Drop-In
- 3-1/2" Center Drain Opening
- Full Undercoat Sound Deadening
- Diamond-Glo Finish
- Includes Mounting Hardware/ Clips and Screws
- Hole Drillings: 3 or 4
- Suggested Cabinet Size: 36"
- Cutout Dimension With 1-1/2" Radius Corners: 32-3/8" x 21-3/8"

ALL DIMENSIONS IN INCHES, TO CONVERT TO MILLIMETERS MULTIPLY BY 25.4.

In keeping with our policy of continuing product improvement, Revere Sink reserves the right to change product specifications without notice.

This specification describes a Revere Sink product with design, quality and functional benefits to the user. When making a comparison of other producers' offerings, be certain these features are not overlooked.