



Revere[®]

CUSTOM STAINLESS STEEL COUNTER TOPS

CREATIVE
expressions

At Revere, we give your vision focus. Do you see a range cut-out in the counter top? Do you visualize rounded stainless steel edges? Revere's custom counter tops and custom sink tops are fabricated to your specifications to make your dream kitchen appear. Fabricated from 18 gauge, Type 304 stainless steel, Revere's durable custom counter top products are enhanced by underside reinforcements and support strips.

Revere's custom counter tops are as beautiful as they are superiorly constructed. Each design is built to provide the most seamless appearance possible. Components are constructed, welded, ground and polished smooth to create a breathtaking whole image. There are no overlapping or soldered edges.

In addition, Revere provides sound deadening to the underside of each counter top and sink. You'll hear more compliments on your design and less unwanted room noise. Plus, each custom counter top features a hand-polished satin finish for a stunning look that stands the test of time.

Let your imagination flow with Revere's custom stainless steel counter top designs

You determine the configuration

Design without limits! If you can imagine it, Revere can build it.

Lasting beauty and support

Quality craftsmanship includes strong integral under-counter reinforcement supports.

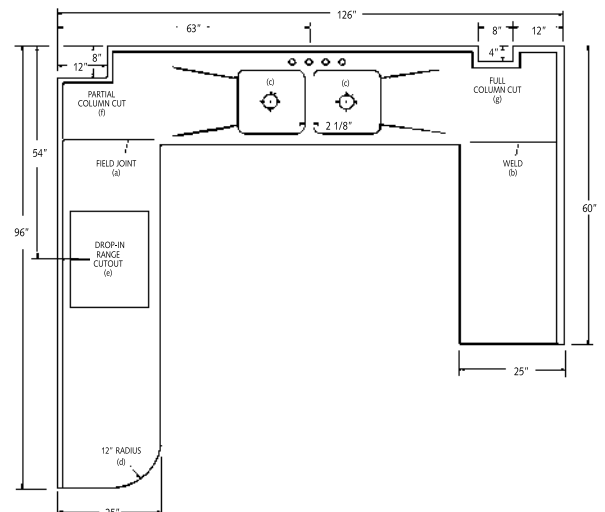
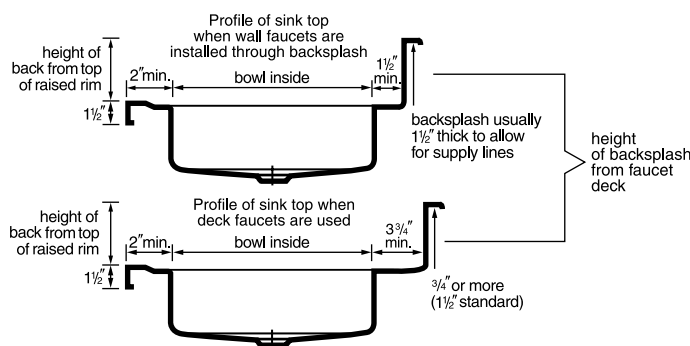
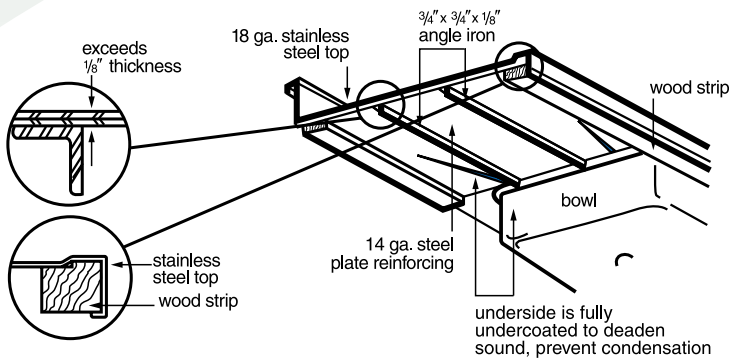

Sink bowl selections



21" x 15-3/4" x 7-3/8" I.D.

Single Bowls

Inside Bowl Dimensions		
Length	Width	Depth
7-1/2	15-3/4	5-5/8
11-1/2	16	7-1/8
12	9-1/4	6-5/8
12	12	7-1/8
12	14	7-1/8
13-1/2	16	7-1/8
14	10	7-1/8
14	14	7-1/8
16	16	7-1/8
18	14	7-1/8
18	20	7-1/8
19	16	7-1/8
21	15-3/4	7-3/8
22	16	7-1/8
24	18	7-1/8
28	16	7-1/8



29-1/8" x 16" x 7-1/8" I.D.

Double Bowl Combinations

Inside Bowl Dimensions		
Length	Width	Depth
7-1/2	15-3/4	5-5/8
11-1/2	16	7-1/8
12	9-1/4	6-5/8
12	12	7-1/8
12	14	7-1/8
13-1/2	16	7-1/8
14	10	7-1/8
14	14	7-1/8
16	16	7-1/8
18	14	7-1/8
19	16	7-1/8
21	15-3/4	7-3/8
22	16	7-1/8
24	18	7-1/8
28	16	7-1/8



11-1/2" x 11-1/2" I.D.



11-3/4" x 13-1/4" I.D.



7" x 14-1/8" I.D.



11-1/2" x 15" I.D.



7-1/2" x 15-3/4" I.D.



21" x 18-5/8" I.D.

Euro Style Bowls

Inside Bowl Dimensions		
Length	Width	Depth
7	14-1/8	5-11/16
7-1/2	15-3/4	5-5/8
11-1/2	11-1/2	6-1/2
11-3/4	13-1/4	6-1/16
11-1/2	15	7-5/8
21	18-5/8	7-5/8
21	18-5/8	10-1/8



21" x 15-3/4" x 9-5/8" I.D.

Deep Single Bowls

Inside Bowl Dimensions		
Length	Width	Depth
11-1/2	16	9-5/8
11-1/2	16	11
12	9-1/4	9-5/8
12	9-1/4	11-5/8
12	12	9-1/2
12	12	11-5/8
12	14	9-5/8
12	14	11-5/8
13-1/2	16	9-5/8
13-1/2	16	11-5/8
14	10	9-5/8
14	14	9-5/8
14	14	11-5/8
16	16	9-5/8
16	16	11-5/8
18	14	9-5/8
18	14	11-5/8
18	20	9-5/8
18	20	11-5/8
19	16	9-5/8
19	16	11-5/8
21	15-3/4	9-5/8
21	15-3/4	11-5/8
22	16	9-5/8
22	16	11-5/8
24	18	9-5/8
24	18	11-5/8
28	16	9-5/8
28	16	11-1/8



29-1/8" x 16" x 9-5/8" I.D.

Deep Double Bowl Combinations

Inside Bowl Dimensions		
Length	Width	Depth
13-1/2	16	9-5/8
13-1/2	16	11-5/8
28	16	11-1/8

Notes

- Faucets and drain fittings are not included with sink tops.
- The above listing represents the most popular standard die-drawn bowl sizes available for seamlessly welding into custom sink tops.
- Custom tops are available with or without integral bowls. Both are normally made in 18 gauge, Type 304 stainless steel with a brush satin finish. Type 316 stainless steel is available where more corrosion resistant material is needed. Tops and some bowls can also be made in thicker 16 gauge or 14 gauge stainless steel.
- See back page for additional features.



15-1/2" x 11-3/8" I.D.

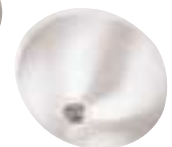

9" I.D.

Oval Bowls (incl. overflow)

Inside Bowl Dimensions		
Length	Width	Depth
13-5/8	10-1/8	5-15/16
15-1/2	11-3/8	6-1/8

Round Bowls

Inside Diameter	Depth
9" Round	5
12" Round	6-1/4
14" Round (including overflow)	7-1/8
16" Round	8-1/8
16" Round Flat Bottom	8-1/8

Contact your local Revere Sales Representative for assistance with specifying and ordering custom products.

How to measure

1. Measure in inches, along wall or walls where top is to be installed.
2. Establish overall counter width, front to back, including thickness of backsplash. Standard width is 25".
3. Determine height of backsplash (measured from top of raised rim).* Standard height is 4". Determine thickness of backsplash. Standard thickness is 1-1/2".
4. Determine sink bowl size and location.
5. List special features such as range cutout, outside radius corners, etc.

* Explanatory Note:

Revere Custom Stainless Steel Counter tops are provided with a standard 5/32" raised rim. Flat rims are available at no additional charge.

How to order

1. When ordering Revere custom made stainless steel sink tops or counter tops, dimensional accuracy is of the utmost importance.
2. Furnish a sketch of sink or counter top arrangement marked with dimensions, and special features. **You cannot provide too much information.**
3. Always include the following information:
 - a) Dimension from end of counter top to **center line** of single sink...**or**
 - b) Dimension from end of counter top to center line of partitions for sinks with two or more bowls.
 - c) Indicate manufacturer's name and complete range unit to be installed if applicable.
 - d) Indicate and locate all cutouts or special conditions.

Custom features available on custom tops

Return Ends

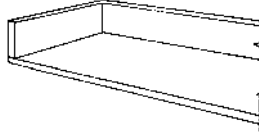

Backsplash Notching

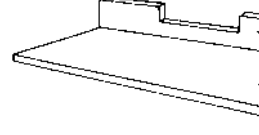

Outside Radius Corners*

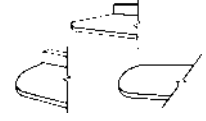

*Not available with bullnose edge

Partial Column Cut

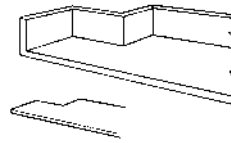

Full Column Cut

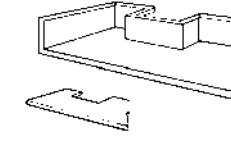

Bullnose Front/Side Edge of Top*

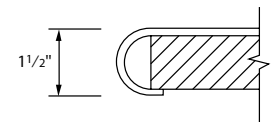

*Not available with outside radius corners

Outside Angle Cuts

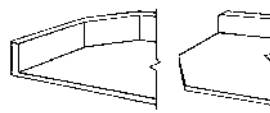

Inside Angle Cuts

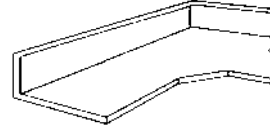

Finished Backsplash

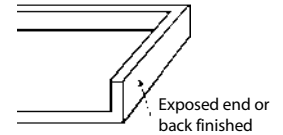

Electrical Cutout

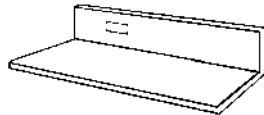

Drop-in Range Opening



Under Shelves (#16 Gauge)

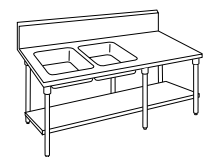

Leg Supports

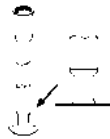

Stainless Steel Support Brackets

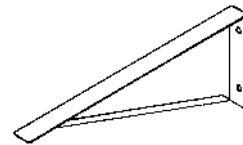

Special Steel Channels

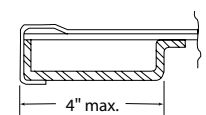

Aprons

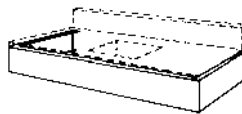

Stainless Steel Flat Rim Shelving

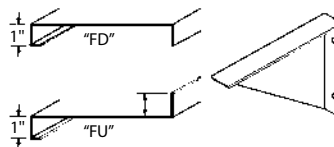

Stainless Steel Raised Rim Shelving

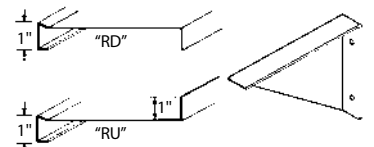

13 Ventura Drive, North Dartmouth, MA 02747
Customer Service (630) 574-8654 www.reveresink.com

© 2003 Revere Sink
Printed in U.S.A.
9/03 RL-375